



**School Alive**  
**Ignite Your Passion**  
**Advent Calendar Plan**

# School Alive Advent Calendar Plan

## Drawer Left Side

25 Small and Large Drawer Pieces

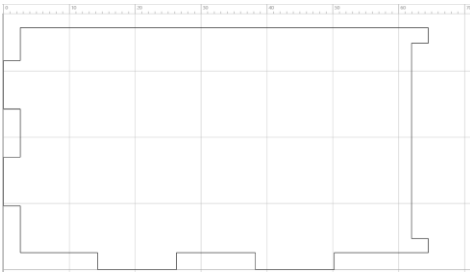

## Drawer Right Side

25 Small and Large Drawer Pieces

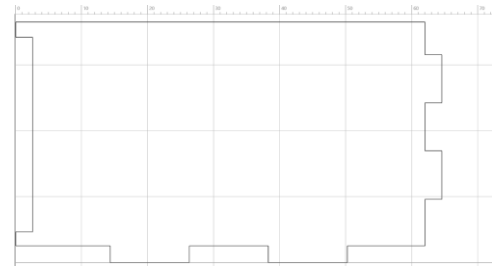

## Drawer Back

24 Small Drawer Pieces

1 Large Drawer Piece

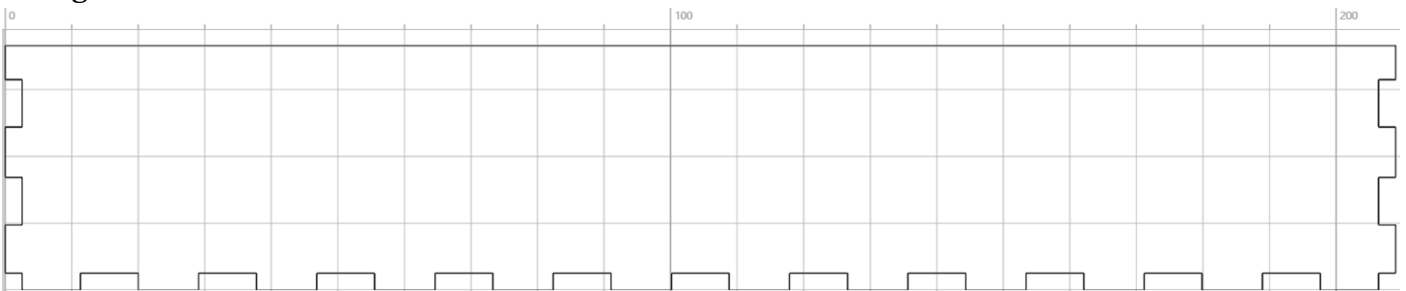
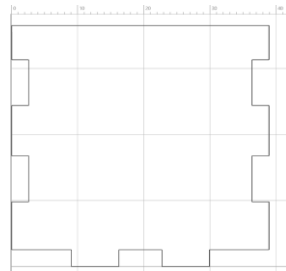

## Drawer Bottom

24 Small Drawer Pieces

1 Large Drawer Piece

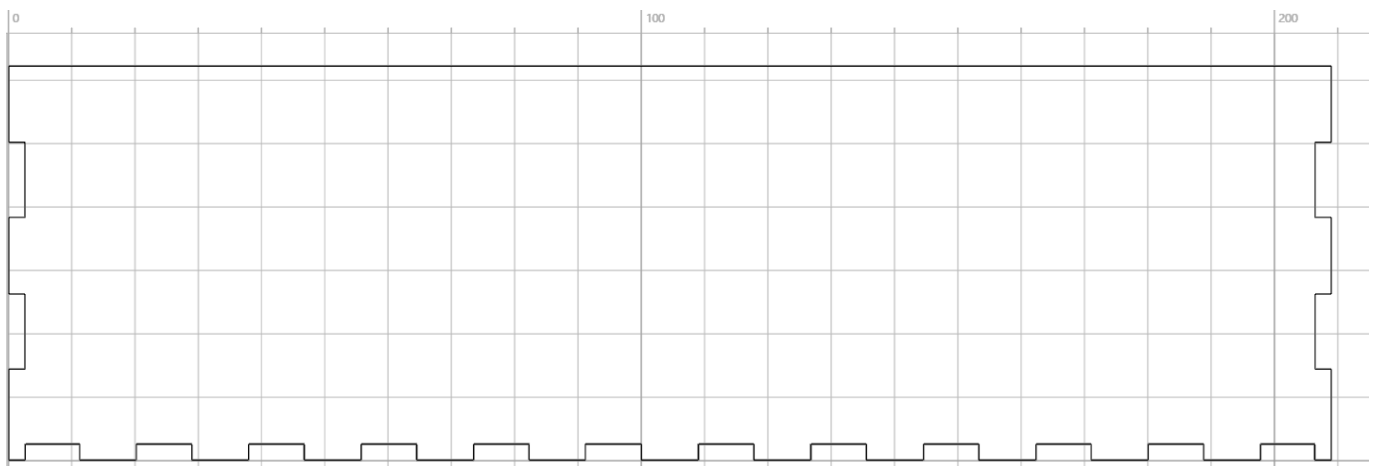
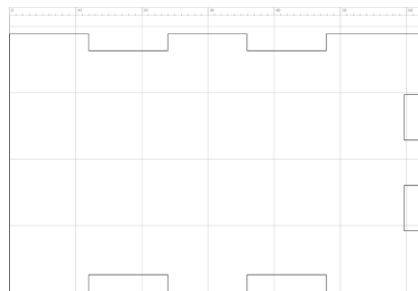

# School Alive Advent Calendar Plan

## Drawer Front

24 Small Drawer Pieces

1 Large Drawer Piece

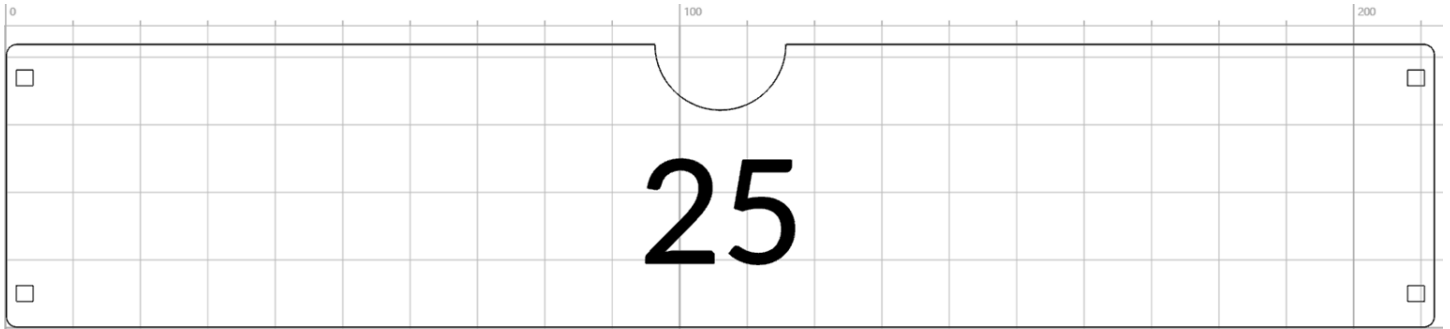
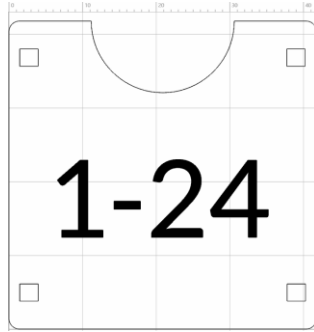

## Top and Bottom Edge Cap

2 Pieces

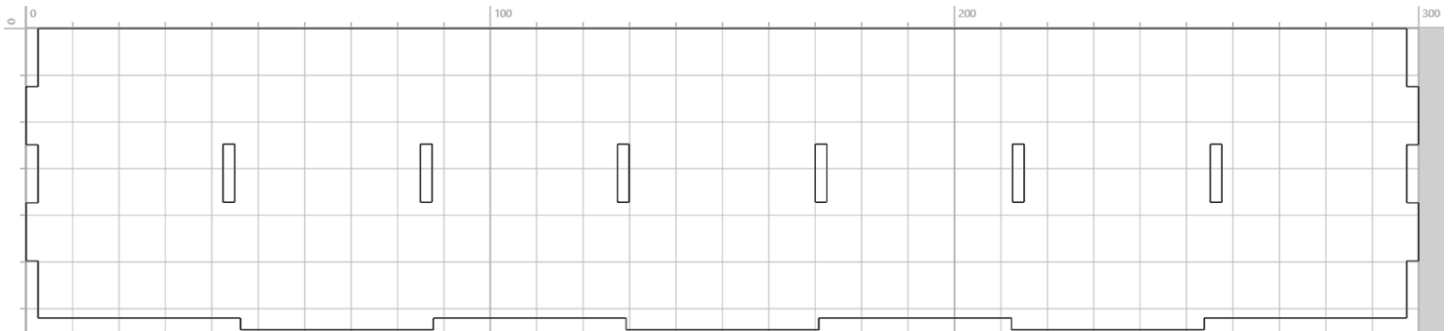

## Left and Right Edge Cap

2 Pieces

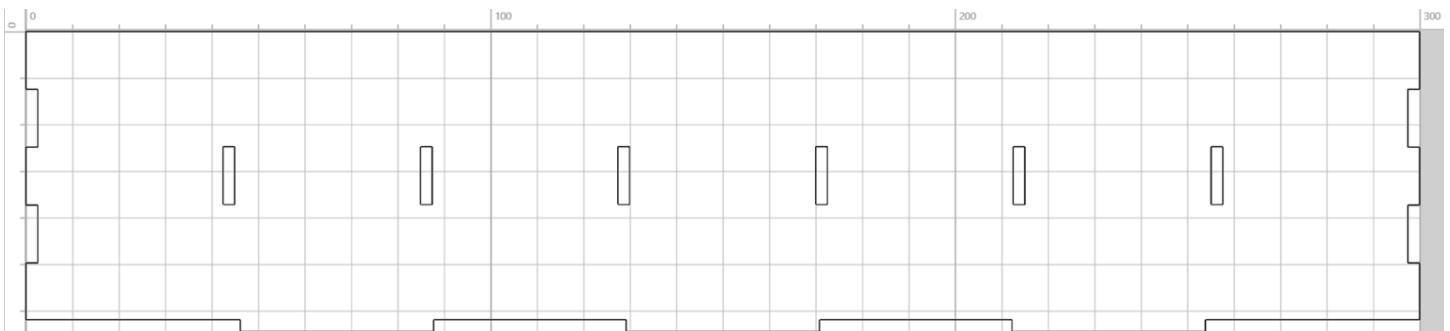

# School Alive Advent Calendar Plan

## Top 3-Panel Picture Cap

1 Piece

Note: Inserts Into Advent Calendar Back

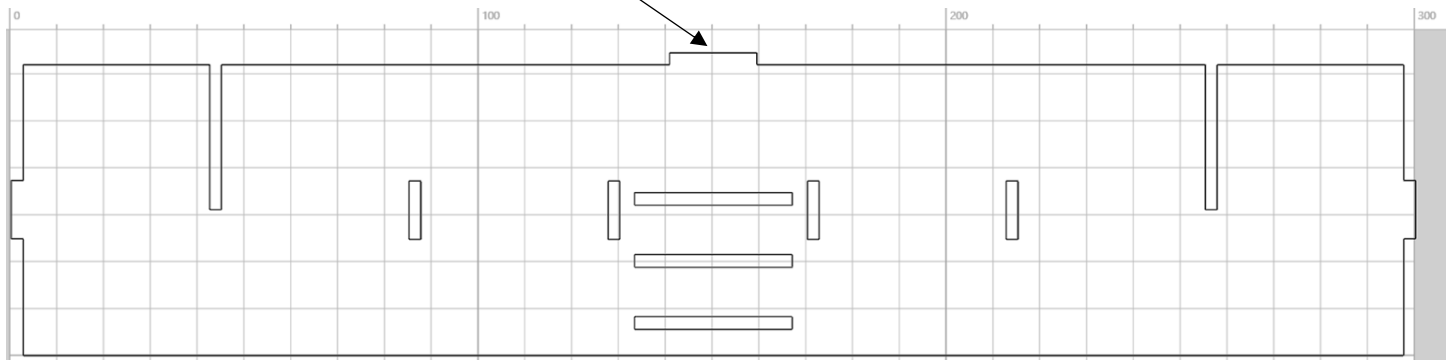

## Bottom 3-Panel Picture Cap

1 Piece

Note: Inserts Into Advent Calendar Back

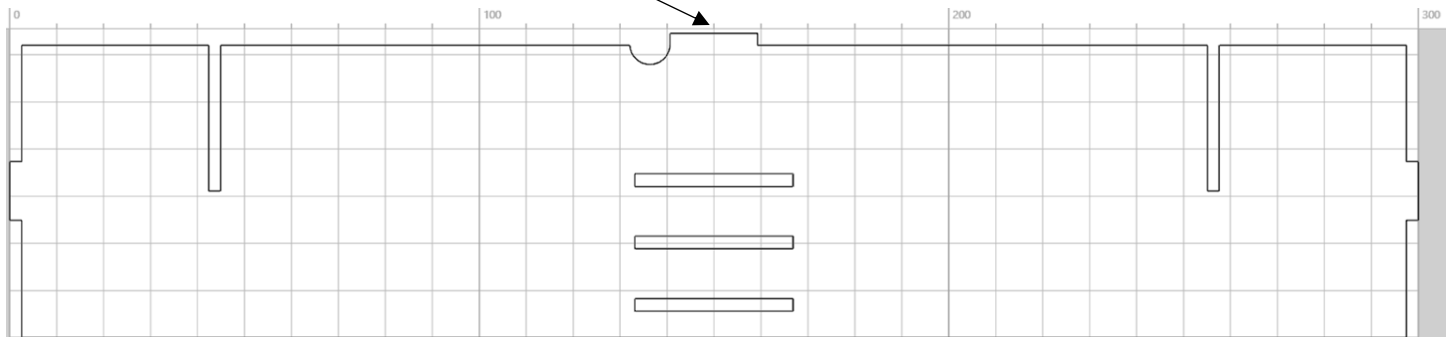

## Left and Right 3-Panel Picture Cap

2 Pieces

Note: Inserts Into Advent Calendar Back

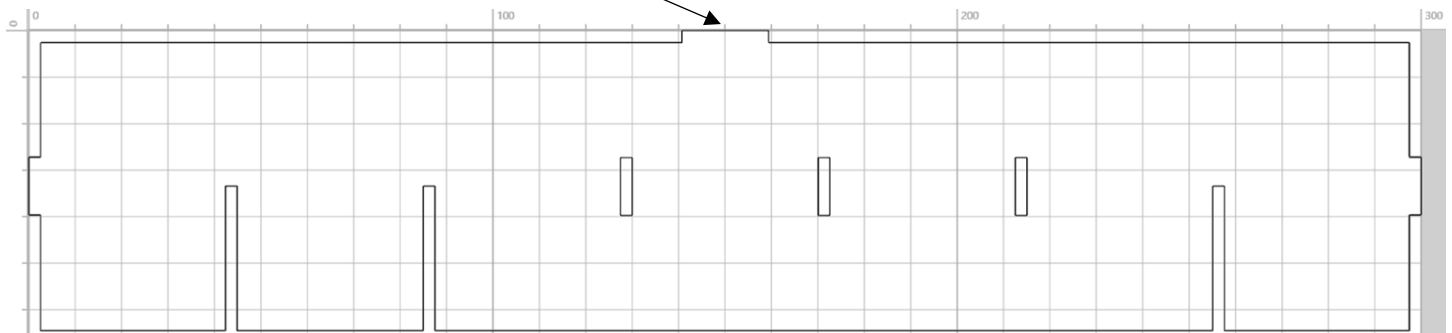

# School Alive Advent Calendar Plan

## Bottom Shelf for Large Drawer

1 Piece

Note: Inserts Into Advent Calendar Back

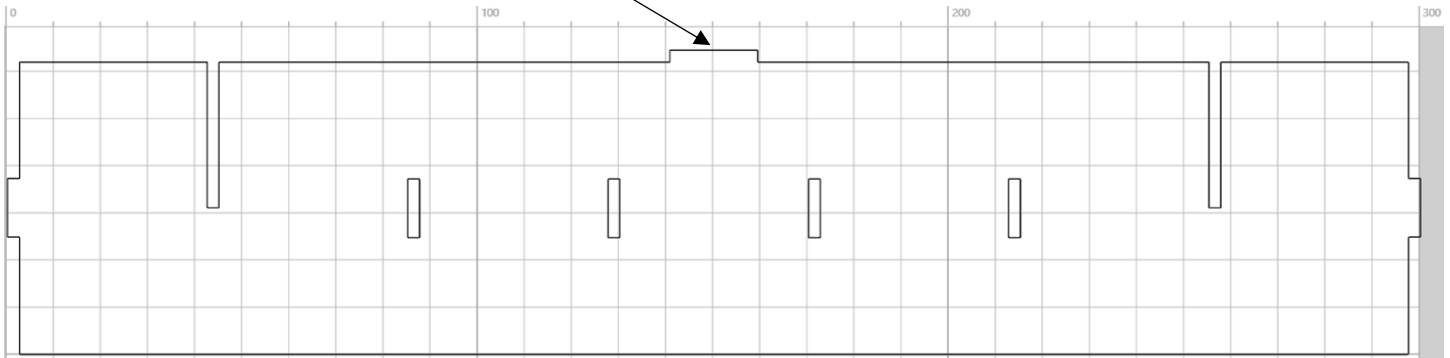

## Shelf Dividers

14 Pieces

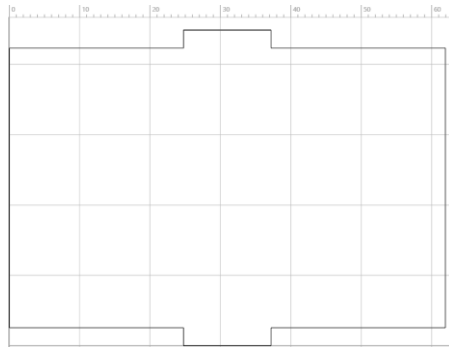

## Back Picture Panel

1 Piece



# School Alive Advent Calendar Plan

## Middle Picture Panel

1 Piece

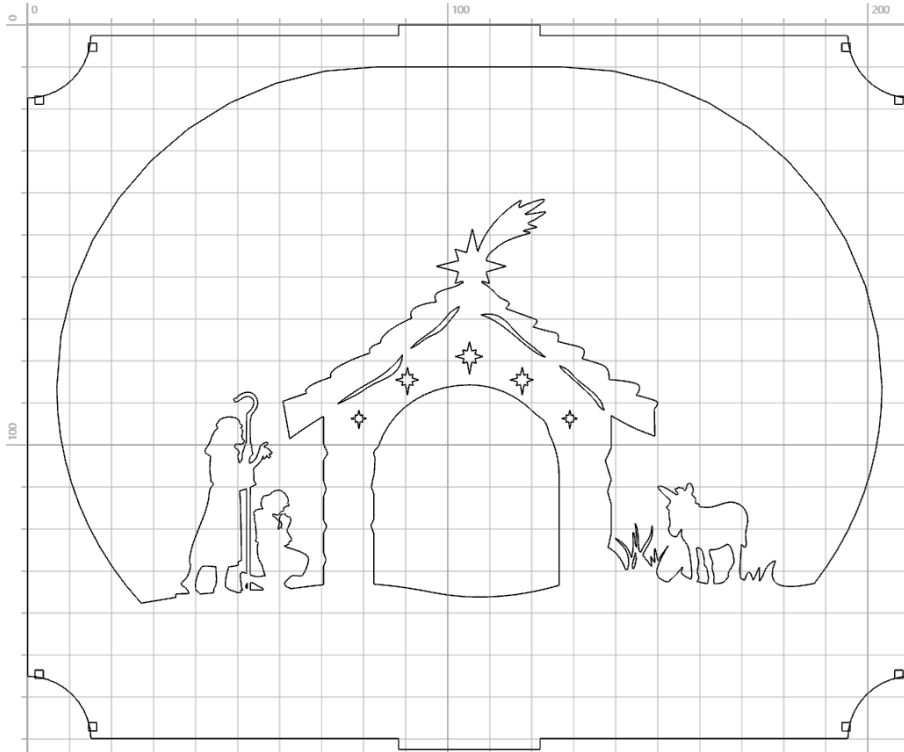

## Front Picture Panel

1 Piece

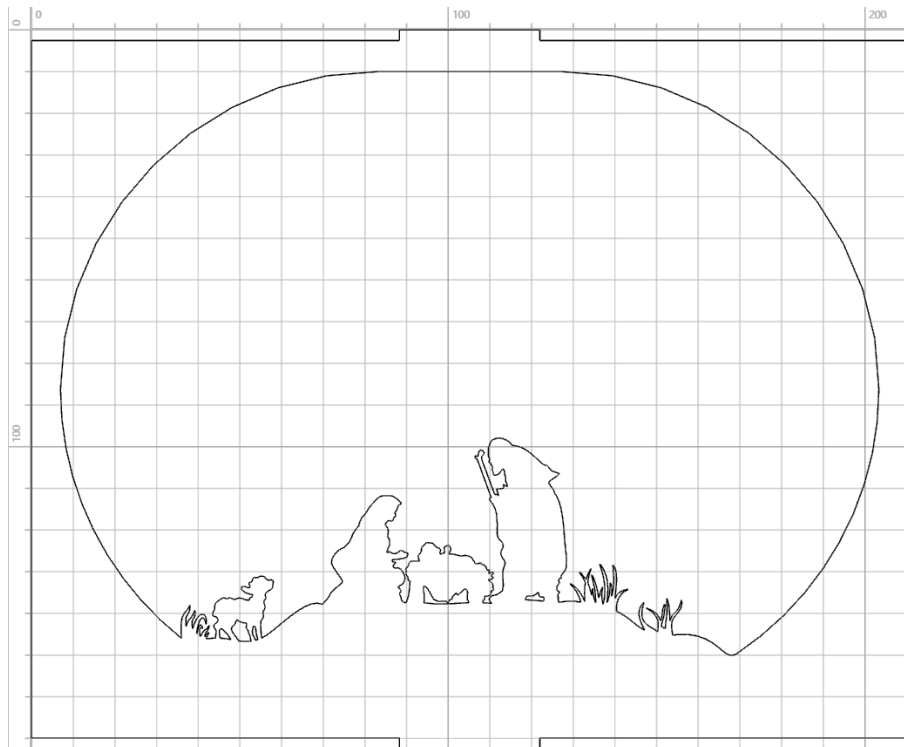

# School Alive Advent Calendar Plan

## Advent Calendar Back

1 Piece



# School Alive Advent Calendar Plan

## Assembly Diagrams

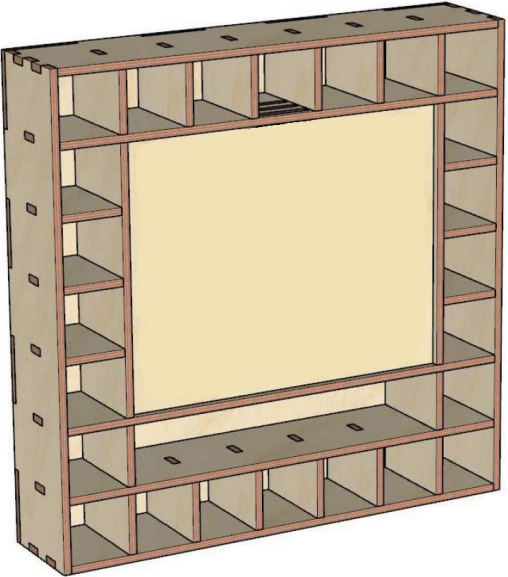
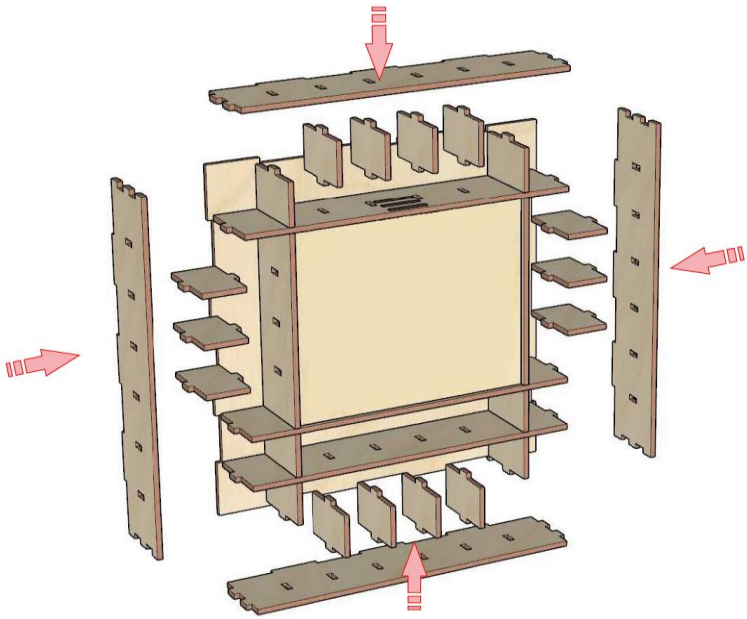
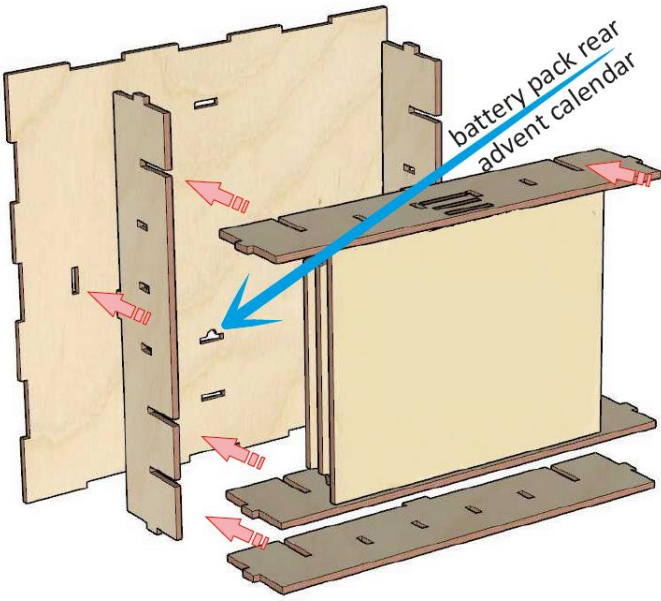
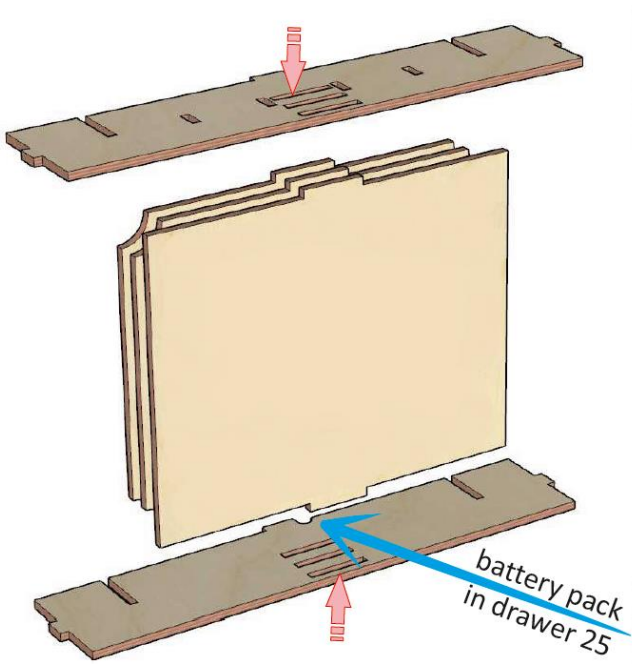



# School Alive Advent Calendar Plan

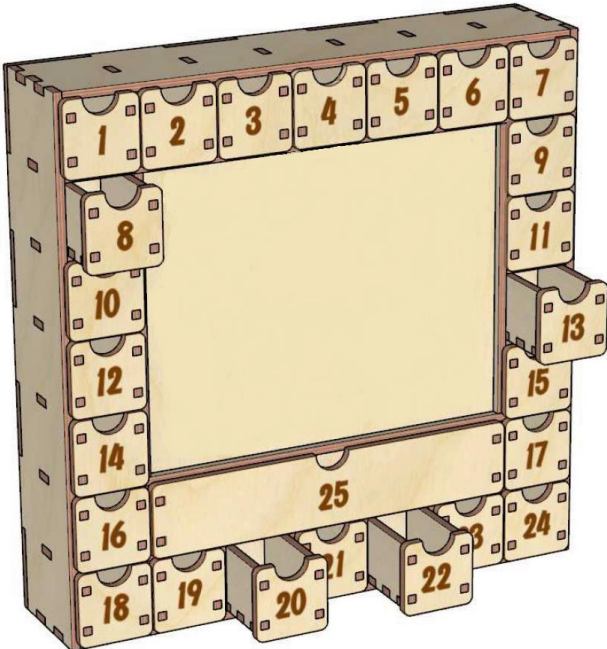
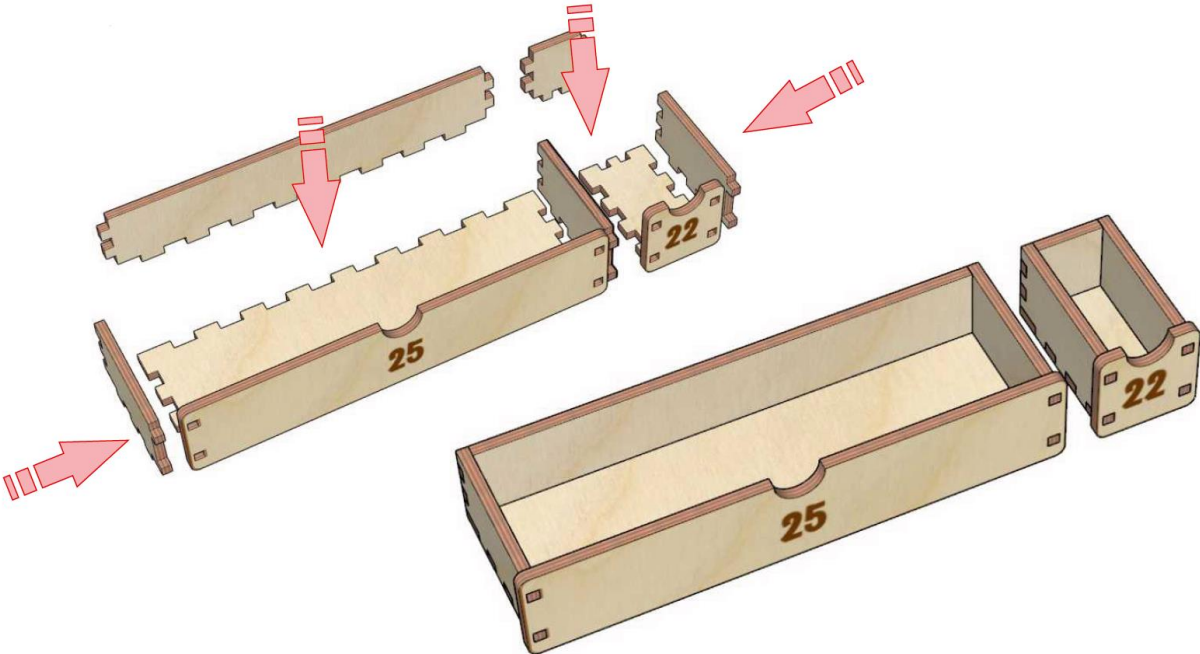

# School Alive Advent Calendar Plan

## Assembly Pictures



# School Alive Advent Calendar Plan

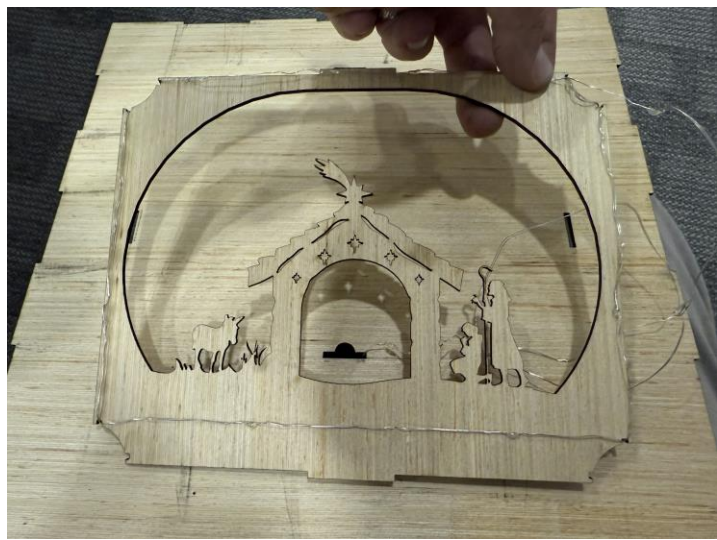
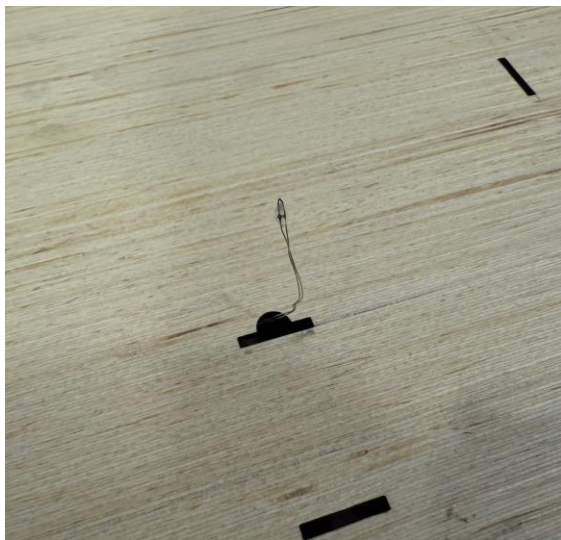
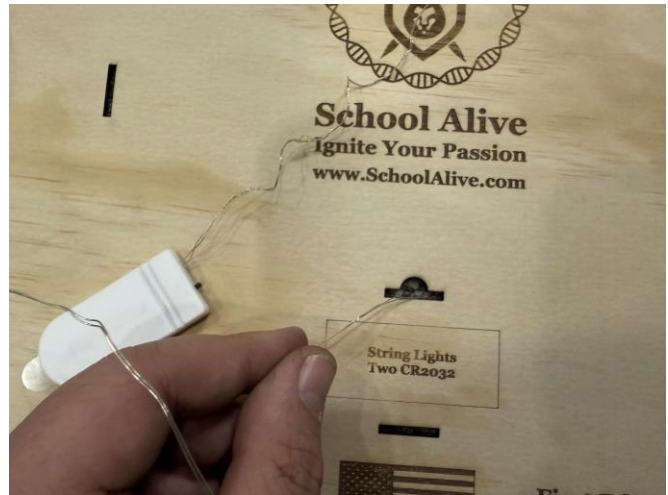
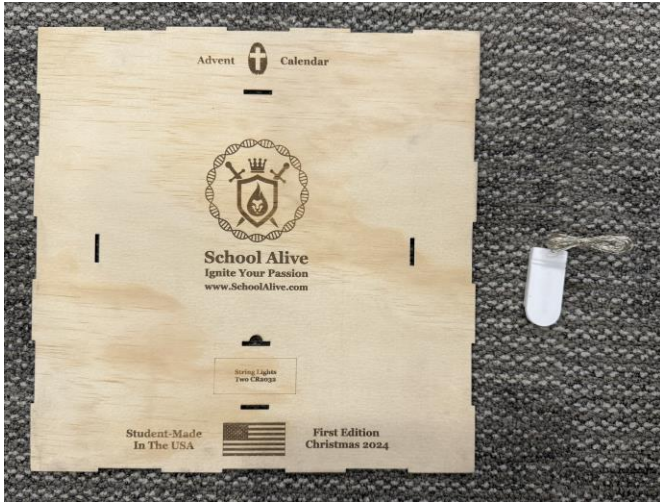

# School Alive Advent Calendar Plan

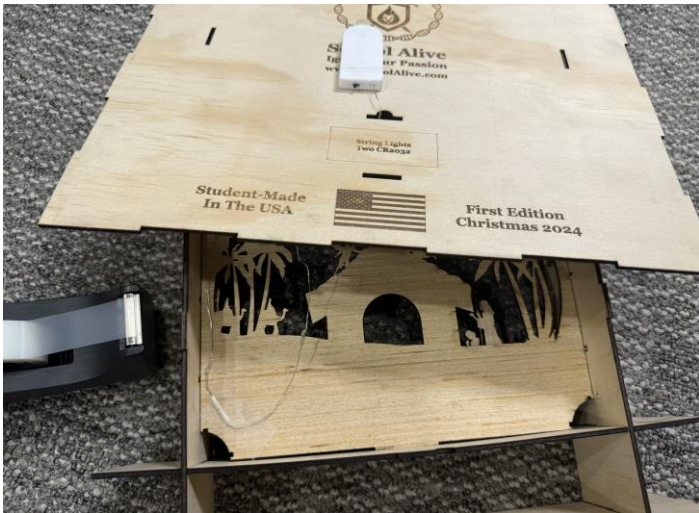

# School Alive Advent Calendar Plan

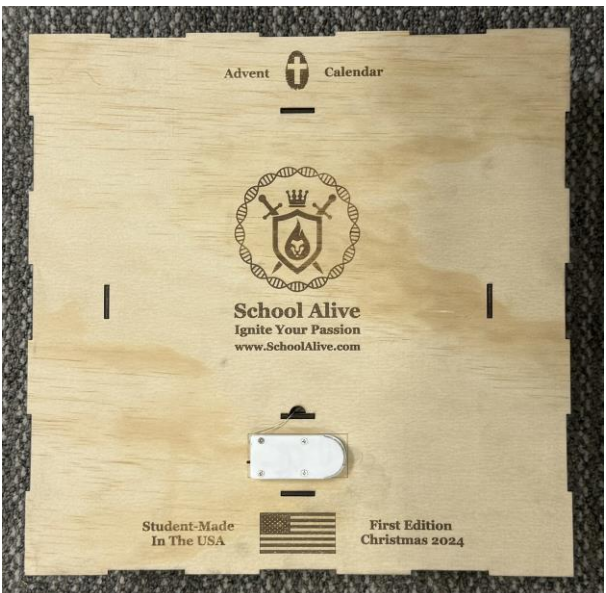
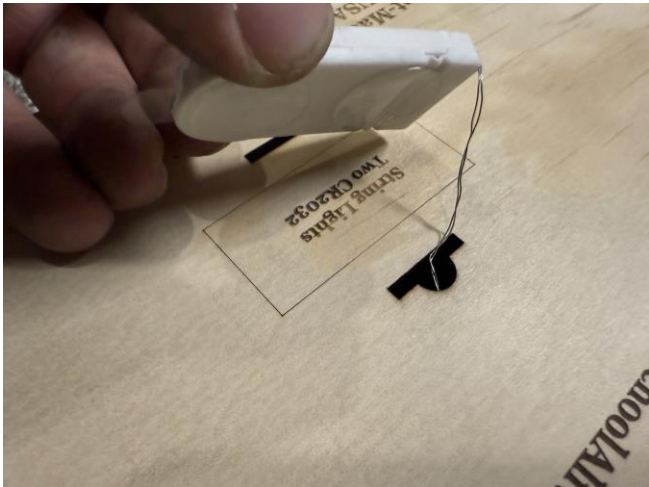

School Alive Advent Calendar Plan



## School Alive Advent Calendar Plan



Note: The pieces are designed with a tolerance of  $\pm 0.05$  mm, allowing for slight variation in fit. This tolerance accounts for natural variability, such as moisture content in the material, which can fluctuate with environmental conditions. While all parts are designed to assemble properly, some pieces may fit more loosely than others. For loose-fitting pieces, the use of glue is optional to ensure a secure fit.

### SUPER GLUE

Applied to gluing Plastic, Metal, Electrics, Ceramics, Toys, Wooden Articles, Rubber, Leather, Paper etc.

#### Note:

- > Keep away from children.
- > Avoid contact with eyes, skin and clothing.
- > Please use the glue within a day after puncturing its seal, since it is very volatile.
- > Aluminum tubes are 2/3 filled to prevent product leakage and extend storage time, but it is ensured that there is 3g of glue in each tube.

### Usage steps



Ensure that the two surfaces to be bonded are clean and dry



Tighten the whole cap of tube firmly to puncture seal

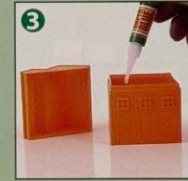

Apply the right amount of glue on one side



Press lightly for 20-50 seconds

- ✓ Easy to use
- ✓ Strong Bond
- ✓ Rapid Drying
- ✓ Lasting Bonding

## **School Alive Advent Calendar Plan**



## School Alive Advent Calendar Plan

### Prophecies of the Messiah (Days 1–7)

#### December 1

- Verse: "For to us a child is born, to us a son is given, and the government will be on his shoulders. And he will be called Wonderful Counselor, Mighty God, Everlasting Father, Prince of Peace" (Isaiah 9:6).
- Explanation: This verse foretells the coming of Jesus as the divine ruler who will bring peace and salvation to the world.
- Reflection: How does knowing Jesus is called "Prince of Peace" bring you comfort during this season?

#### December 2

- Verse: "But you, Bethlehem Ephrathah, though you are small among the clans of Judah, out of you will come for me one who will be ruler over Israel, whose origins are from of old, from ancient times" (Micah 5:2).
- Explanation: Bethlehem, though small and humble, is chosen as the birthplace of the eternal King.
- Reflection: How does God's choice of Bethlehem encourage you about His plans for the humble and lowly?

#### December 3

- Verse: "Therefore the Lord himself will give you a sign: The virgin will conceive and give birth to a son, and will call him Immanuel" (Isaiah 7:14).
- Explanation: This verse predicts the miraculous birth of Jesus, who will be "God with us."
- Reflection: How does the name "Immanuel" remind you of God's presence in your life?

#### December 4

- Verse: "'The days are coming,' declares the Lord, 'when I will fulfill the good promise I made to the people of Israel and Judah'" (Jeremiah 33:14).
- Explanation: God promises to send the Messiah to fulfill His covenant of restoration and hope.
- Reflection: How does this promise of hope help you trust God's timing?

#### December 5

- Verse: "Rejoice greatly, Daughter Zion! Shout, Daughter Jerusalem! See, your king comes to you, righteous and victorious, lowly and riding on a donkey, on a colt, the foal of a donkey" (Zechariah 9:9).
- Explanation: This prophecy speaks of Jesus as the humble King who brings righteousness and salvation.
- Reflection: How can you celebrate and rejoice in Jesus' humility and kingship today?

#### December 6

- Verse: "I see him, but not now; I behold him, but not near. A star will come out of Jacob; a scepter will rise out of Israel. He will crush the foreheads of Moab, the skulls of all the people of Sheth" (Numbers 24:17).
- Explanation: This verse points to Jesus as the star of hope and ruler from Israel.
- Reflection: How does Jesus' light guide you in times of uncertainty?

#### December 7

- Verse: "And through your offspring all nations on earth will be blessed, because you have obeyed me" (Genesis 22:18).
- Explanation: God promises Abraham that his descendants will bring blessing to all nations, fulfilled in Jesus.
- Reflection: How does Jesus' global blessing inspire you to share His love with others?

### The Announcements (Days 8–14)

#### December 8

- Verse: "But the angel said to him: 'Do not be afraid, Zechariah; your prayer has been heard. Your wife Elizabeth will bear you a son, and you are to call him John'" (Luke 1:13).
- Explanation: God answers Zechariah's prayers with the miraculous promise of John the Baptist.
- Reflection: What prayers are you waiting for God to answer, and how can you trust Him during the wait?

## **School Alive Advent Calendar Plan**

## School Alive Advent Calendar Plan

### December 9

- Verse: "The angel went to her and said, 'Greetings, you who are highly favored! The Lord is with you'" (Luke 1:28).
- Explanation: Mary is chosen by God to bear His Son, a display of His grace and favor.
- Reflection: How does knowing God's favor rest on you through Jesus encourage you?

### December 10

- Verse: "You will conceive and give birth to a son, and you are to call him Jesus" (Luke 1:31).
- Explanation: Gabriel announces the Savior's name, which means "God saves."
- Reflection: How does the name "Jesus" remind you of His mission to save you?

### December 11

- Verse: "'I am the Lord's servant,' Mary answered. 'May your word to me be fulfilled.' Then the angel left her" (Luke 1:38).
- Explanation: Mary humbly submits to God's plan, trusting in His purpose.
- Reflection: How can you follow Mary's example of trust and surrender to God's will?

### December 12

- Verse: "But after he had considered this, an angel of the Lord appeared to him in a dream and said, 'Joseph son of David, do not be afraid to take Mary home as your wife, because what is conceived in her is from the Holy Spirit'" (Matthew 1:20).
- Explanation: Joseph is reassured by God to take his place in Jesus' story.
- Reflection: When have you felt God call you to overcome fear and trust Him?

### December 13

- Verse: "She will give birth to a son, and you are to give him the name Jesus, because he will save his people from their sins" (Matthew 1:21).
- Explanation: Jesus' mission is revealed: to bring salvation to His people.
- Reflection: What does it mean to you personally that Jesus saves from sin?

### December 14

- Verse: "Blessed is she who has believed that the Lord would fulfill his promises to her!" (Luke 1:45).
- Explanation: Elizabeth affirms Mary's faith in God's promises.
- Reflection: How can you show faith in God's promises today?

### Mary's Praise & Zechariah's Prophecy (Days 15–17)

### December 15

- Verse: "And Mary said: 'My soul glorifies the Lord'" (Luke 1:46).
- Explanation: Mary's praise (Magnificat) begins with her recognition of God's greatness and His work in her life.
- Reflection: How can you glorify God for His blessings in your life today?

### December 16

- Verse: "For the Mighty One has done great things for me—holy is his name" (Luke 1:49).
- Explanation: Mary reflects on God's power and holiness as she marvels at His personal work in her life.
- Reflection: What "great things" has God done for you that you can thank Him for?

### December 17

- Verse: "Praise be to the Lord, the God of Israel, because he has come to his people and redeemed them" (Luke 1:68).
- Explanation: Zechariah praises God for His faithfulness and the coming redemption through the Messiah.
- Reflection: How does the promise of redemption give you hope during this season?

### The Journey to Bethlehem (Days 18–21)

### December 18

- Verse: "In those days Caesar Augustus issued a decree that a census should be taken of the entire Roman world" (Luke 2:1).
- Explanation: God orchestrates even political events to fulfill His plan for the birth of Jesus in Bethlehem.
- Reflection: How can you trust God's sovereignty over events in your life?

# **School Alive Advent Calendar Plan**

## School Alive Advent Calendar Plan

### December 19

- Verse: "So Joseph also went up from the town of Nazareth in Galilee to Judea, to Bethlehem the town of David, because he belonged to the house and line of David" (Luke 2:4).
- Explanation: Joseph fulfills prophecy as he travels to Bethlehem, the prophesied birthplace of the Messiah.
- Reflection: How can you follow God's direction even when the journey feels difficult?

### December 20

- Verse: "He went there to register with Mary, who was pledged to be married to him and was expecting a child" (Luke 2:5).
- Explanation: Joseph and Mary's obedience to God's plan shows their trust, even amidst uncertainty.
- Reflection: What steps of obedience is God asking you to take in faith?

### December 21

- Verse: "While they were there, the time came for the baby to be born" (Luke 2:6).
- Explanation: God's perfect timing brings the fulfillment of His promises.
- Reflection: How can you trust God's timing in your life, even when waiting is hard?

### The Birth of Jesus (Days 22–25)

#### December 22

- Verse: "And she gave birth to her firstborn, a son. She wrapped him in cloths and placed him in a manger, because there was no guest room available for them" (Luke 2:7).
- Explanation: Jesus' humble birth in a manger reflects God's approachability and His love for all people.
- Reflection: How does Jesus' humility inspire you to live with simplicity and gratitude?

#### December 23

- Verse: "But the angel said to them, 'Do not be afraid. I bring you good news that will cause great joy for all the people'" (Luke 2:10).
- Explanation: The angel announces Jesus' birth as a source of joy and hope for all humanity.
- Reflection: How can you share the "good news" of Jesus with someone this week?

#### December 24

- Verse: "Today in the town of David a Savior has been born to you; he is the Messiah, the Lord" (Luke 2:11).
- Explanation: The angels declare Jesus as the long-awaited Savior and King.
- Reflection: What does it mean to you personally that Jesus is your Savior and Lord?

#### December 25

- Verse: "Glory to God in the highest heaven, and on earth peace to those on whom his favor rests" (Luke 2:14).
- Explanation: The heavenly host praises God for the peace and favor He brings through Jesus.
- Reflection: How can you glorify God today as you celebrate the birth of Jesus?